

ACORN

PLATENS • STANDS • TOOLS

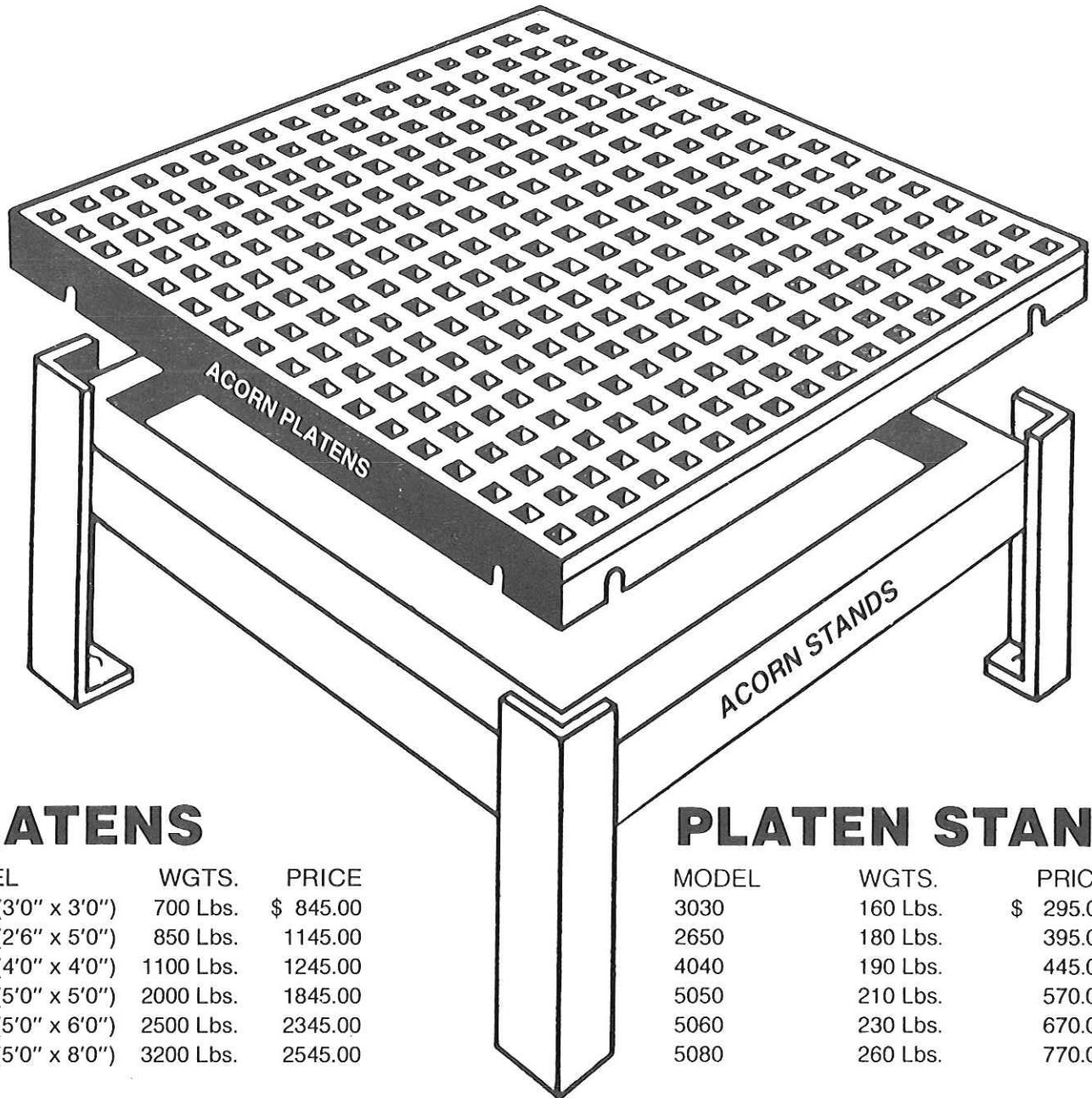

PLATENS

MODEL	WGTS.	PRICE
3030 (3'0" x 3'0")	700 Lbs.	\$ 845.00
2650 (2'6" x 5'0")	850 Lbs.	1145.00
4040 (4'0" x 4'0")	1100 Lbs.	1245.00
5050 (5'0" x 5'0")	2000 Lbs.	1845.00
5060 (5'0" x 6'0")	2500 Lbs.	2345.00
5080 (5'0" x 8'0")	3200 Lbs.	2545.00

PLATEN STANDS

MODEL	WGTS.	PRICE
3030	160 Lbs.	\$ 295.00
2650	180 Lbs.	395.00
4040	190 Lbs.	445.00
5050	210 Lbs.	570.00
5060	230 Lbs.	670.00
5080	260 Lbs.	770.00

ACORN IRON & SUPPLY CO., INC.

915 North Delaware Avenue
Philadelphia, PA 19123

215-922-7070 • TAX # 215-922-2522

ALL PRICES F.O.B.
PHILADELPHIA

TOOLS

PRICES QUOTED
IN U.S. FUNDS

Over 80 Years of Progress



Sterling
MACHINERY FACTORY

www.SterlingMachinery.com

ACORN TOOLS

HORIZONTAL CLAMPS

With hardened screw, swivel cap and sliding handle.

\$54.75 ea.

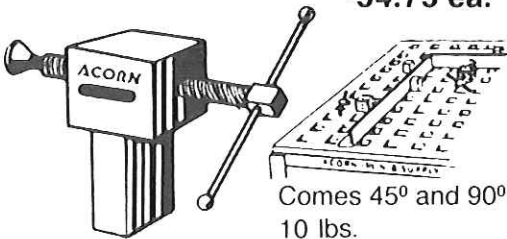

Comes 45° and 90°.
10 lbs.

TAPERED DRIFT PIN

10 inches long.
9 lbs.



\$29.75 ea.

PLATEN VISE

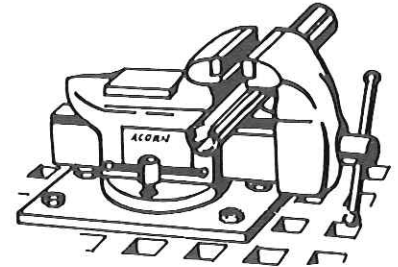

Jaw width 5", opens 5 1/2", pipe size 1/8" to 2 1/2". 40 lbs.

\$120.75 ea.

GOOSENECK HOLD-DOWN DOG

Hand-forged steel,
15" throat
17 lbs.



\$39.75 ea.

BENDING POST

12 lbs.



\$34.75 ea.

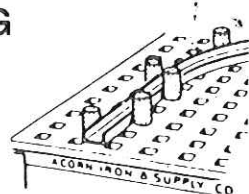

ARM CLAMP

With clamping screw, swivel cap, sliding handle, complete with a special hold-down bolt, nut and washer. 7 lbs.

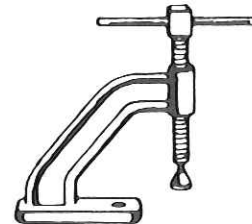

\$59.75 ea.

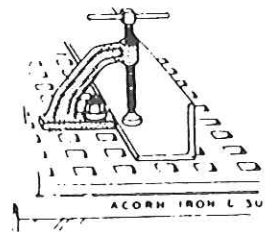

ACORN BURNING PYRAMID

2 lbs.
Slot - 9/16"
W, 4 3/16" H
\$2.75 ea.



HOLD-DOWN BOLT & NUT

With Special Forged Head; nut and washer included.

3 3/4" 1 1/2 lbs. \$7.75 ea.
4 3/4" 1 3/4 lbs. \$7.75 ea.
10" 2 lbs. \$9.75 ea.

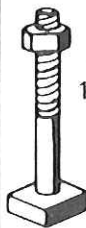

\$9.75 ea.

45° CLAMP

Has sliding handle and swivel cap.
Handle open, 11";
handle closed, 2 1/2";
stem, 2 1/2" L.
x 1 1/2" W. 12 lbs.

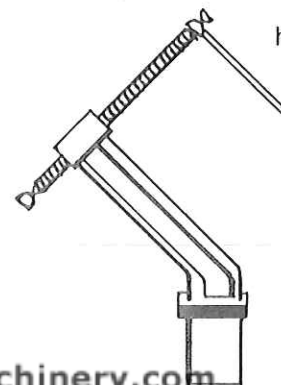

\$59.75 ea.

"Y" & ARROW POST

Overall height 8 3/4"; above platen,
6 1/4"; stem, 2 1/2" L. x 1 1/2" W. 5 lbs.

\$39.75 ea.

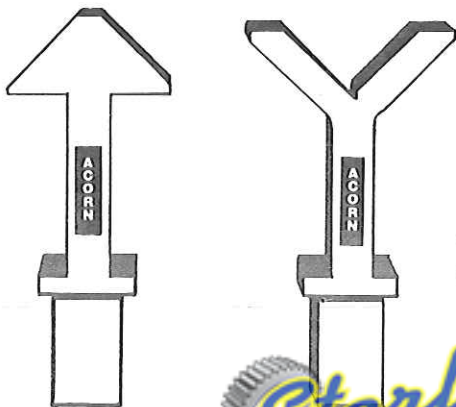

Sterling
MACHINERY EXCHANGE

www.SterlingMachinery.com

ACORN IRON & SUPPLY CO., INC.

Home of Acorn Platens

Loading Capacity of Welding Platens:

Platen Size:	On Stand	Without Stand
#3030	4 tons	6 tons
#2650	4 tons	6 tons
#4040	4 tons	6 tons
#5050	6 tons	8 tons
#5060	6 tons	8 tons
#5080	6 tons	8 tons

NOTE: 1) Loading onto the platen is to be jerk free and without impact.
Load **MUST** be centered.

2) Platen stand, if used, should be securely fastened to the floor.

Platen Flatness:

Platens are machined to .005" per linear foot, they are not blanchard ground.

NOTE: Platens Are Not Manufactured In USA.

Stands and Tools Are Manufactured In USA.





www.SterlingMachinery.com